

**42L/52L/62L  
Fridge/Freezer  
GH-2000/GH-2002/GH-2004  
User Manual**



## FEATURES

- DC power connections  
Powered by AC using the AC to DC power adapter
- High-efficiency DC compressor and conversion module
- Dual mode operation (Max & Economy)
- Digital temperature display with adjustable control
- 3 Year Warranty
- 3-stage low voltage battery protection
- USB port to charge USB devices
- Handle and wheels
- APP control Via Bluetooth

## BOX CONTENTS

1 x Portable Fridge/Freezer  
1 x 12/24V Car Cigarette Power Lead  
1 x 240VAC to 12VDC power adapter

## SPECIFICATIONS

Input Voltage:	12/24VDC
Average Power Consumption:	45W
Power Consumption:	0.25kw.h/24hr
Rated Current:	3.8A/1.9A
Temperature Range:	-20°C to +20°C (with ambient temperature at 25°C)
Refrigerant:	R134a
Insulation:	100% CFC & HFC free PU Foam insulation

## SAFETY

- The installation of DC power sources in a boat must be handled by a qualified electrician
- Make sure to connect power to the suitable voltage socket
- No electrical devices are to be used inside the product
- The product can be powered on only after being unpacked and put on a flat level surface for over 6 hours
- Fridge operating angle:- The fridge can be operated indefinitely at up to 5 degrees, and can be operated at between 6 and 45 degrees for up to 30mins.
- Product must be well ventilated. Ensure there is a minimum of 200mm clearance at the back, and 100mm around the sides
- The product should be in a well-ventilated space, away from heat sources. Try to avoid direct exposure to sunlight
- Keep product stable
- When there is water inside the fridge, do not turn the product upside down to empty. Dry the water with a soft cloth.
- Do not put metal in the air inlet vent, outlet vent, or gap
- Do not connect to other power except 12V/21VDC, or the 240VAC to 12VDC adapter
- Do not soak the product in water or wash with water
- The product should not be repaired. If there is any issues please consult the place of purchase
- Turn off the product before cleaning to avoid electric shocks or other issues
- Keep product away from wet or humid places

# DIMENSIONS

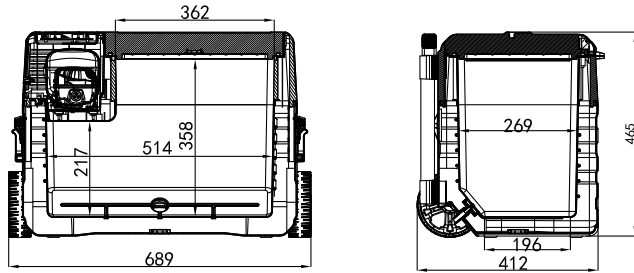

## GH-2000

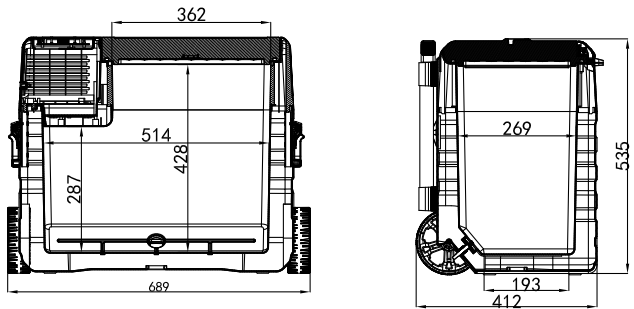

## GH-2002

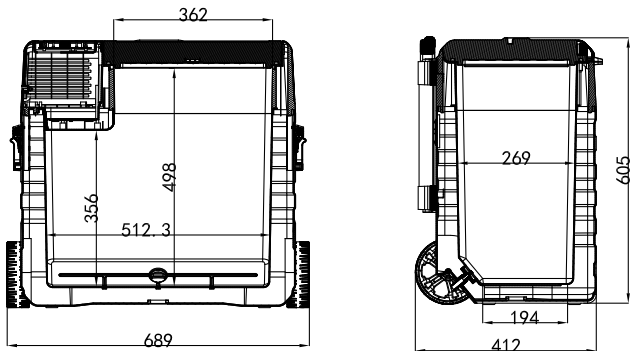

## GH-2004

# OPERATION

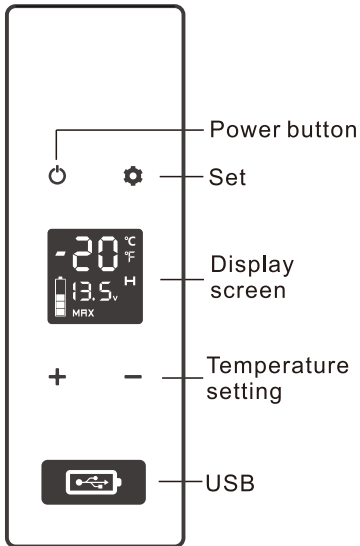

- **How to Turn on the Fridge**

1. Connect to power

2. Press button 

3. The internal temperature will display and the compressor will start

- **SET:** Press button  to enter different modes, ECO (Energy Saving Mode), and MAX (Fast Cooling Mode). Factory setting is MAX

- Press button + or - and set the temperature to 20°C ~ -20°C

## USING IN CAR

The product has a three-level battery protection function, which not only guarantees the normal operation of the product, but also protect the battery of the vehicle. When in the power-on state, long press SET button for 3 seconds and the display screen flashes H, select low voltage production L(ow), M(edium), and H(igh) by clicking SET button. The factory default is set to H(igh) protection.



H should be set when the product is connected to car power, and M or L should be set when it is connected to a portable battery or other back-up battery. Because of the different output voltages between vehicles, the battery gear can be set from H to M or from M to L if there is a voltage protection code F1 shown on the panel. The battery gear should be set to H if the product will keep working after turning off the car engine, or the product may drain the battery.

# SMART CONTROL FRIDGE APP APPLICATION INSTRUCTION

## Downloading the "BRASS MONKEY FRIDGE" Application

- Using a pre-installed QR reader on your handheld smart device scan the QR code in the manual or search for "BRASS MONKEY FRIDGE" App Store (for Apple devices) or Google store (Android Devices).
- Start the application and select the "Search " function.
- The application will prompt you to pair the fridge by pressing the "set button ⚙️ " on the fridge's control panel. Once "set button ⚙️ " has been activated, the fridge will be paired with your smart device and the application will switch to a control panel allowing you to control the fridge's functions.

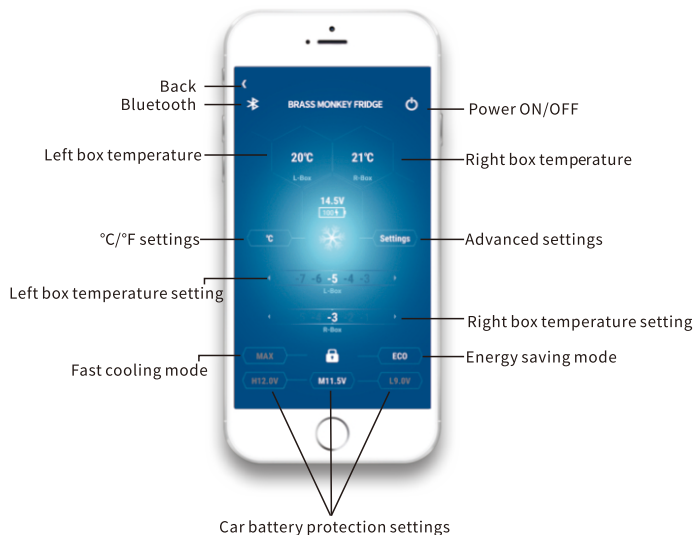

Please scan the QR code to download APP

QR Code for Apple Devices



QR Code for Android Devices



## CLEANING & MAINTENANCE

1. Do not wash the product with water or soak.
2. Please disconnect from power before cleaning the product to avoid electrical shock.

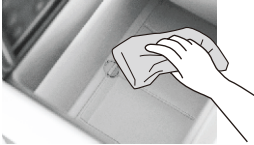

3. Drain the product simply by removing the plug at the bottom.
4. Clean it with a soft wet cloth.

If you will not use the product for a long period of time, ensure you:



1. Turn it off and disconnect from power.
2. Remove everything from inside (food, drinks, etc)
3. Drain any remaining water by removing the drain plug, then wipe all internal surfaces with a soft cloth to ensure that they are clean and dry.
4. Keep it stored away from wet or humid places.

## TROUBLESHOOTING

- The product is not working:
  - If using the 240VAC to 12VDC adapter check the power supply is working
  - If using the DC cable please ensure the cable still works.
  - Check the power supply is working
  - Check if the plug and socket are connected
  - Check the fuse
  - Check power switch on control panel is on
  - Compressor starts delay protection for 3 minutes after turning on
- Food inside the product is frozen:
  - Temperature is set too low
- Water flowing sound inside the tank:
  - Refrigerant is flowing, this is normal



- Water drops around the case or door gap:
  - When moisture in the air meets the lower temperature case, it will naturally become liquefied and condensed. Wipe away with a towel or soft cloth
- Code F1 displayed:
  - Low voltage protection, which can be solved by setting the battery protection button from H to M or from M to L
- Code F2 displayed:
  - Fan overload protection. Please turn off the product and restart it after 30 minutes. If the code displays again, please contact the place of purchase
- Code F3 displayed:
  - Compressor frequent start protection. Please turn off the product and restart it after 30 minutes. If the code displays again, please contact the place of purchase
- Code F4 displayed:
  - Compressor is overloaded or working at a low speed. Please turn off the product and restart it after 30 minutes. If the code displays again, please contact the place of purchase
- Code F5 displayed:
  - High temperature compressor module protection. Please move the product to a ventilated area and turn it off for 30 minutes then restart it. If the code displays again, please contact the place of purchase
- Code F6 displayed:
  - No parameter can be detected by the controller. Please restart the product. If the code displays again, please contact the place of purchase
- Code F7 / F8 displayed:
  - Temperature sensor error protection. Please check the sensor terminal

The warranty for this product is 3 years from date of purchase. During the warranty period the following are excluded from coverage:

- Intentional damage
- Damage by fire, flood, etc
- Damage or malfunction caused by incorrect usage and not following this user manual
- Damage or malfunction caused by disassembling